

MIT SEITLICHEM CHIP UND MITTELBOHRER.

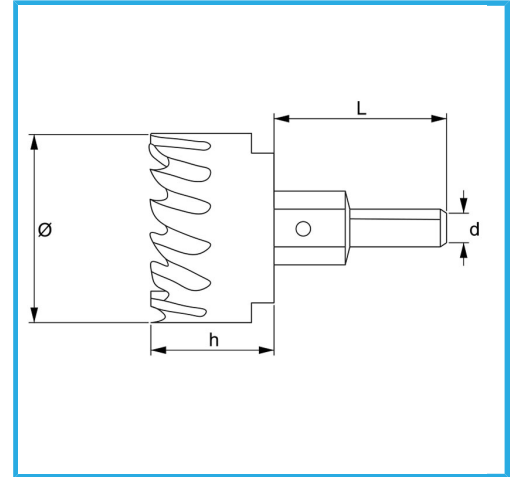

Ø	53 mm
h	23 mm
d	12 mm
L	46 mm
Gewinde	M16 x 1,5
Bruttogewicht	0,35 kg
Verpackungsmaße	75x75x120 h mm
EAN-Code	8012667313883



Aufhängbar

HSS