

MIT SEITLICHEM CHIP UND MITTELBOHRER.

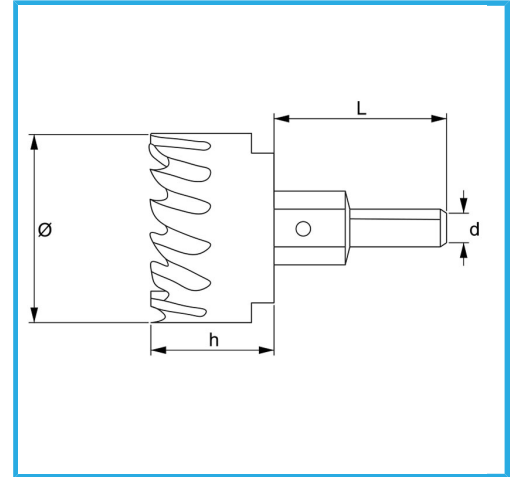

Ø	54 mm
h	23 mm
d	12 mm
L	46 mm
Gewinde	M16 x 1,5
Bruttogewicht	0,35 kg
EAN-Code	8012667313890



Aufhängbar

HSS