

MIT SEITLICHEM CHIP UND MITTELBOHRER.

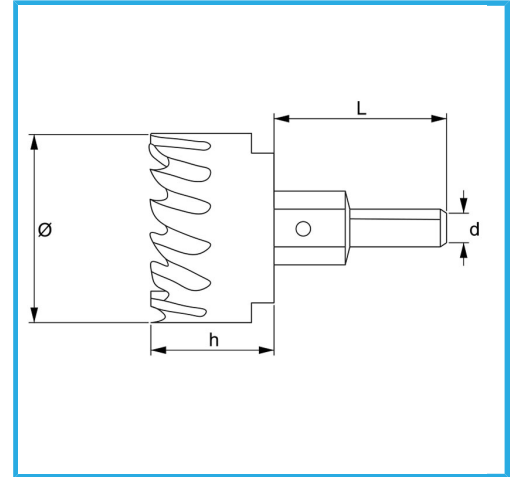

Ø	70 mm
h	23 mm
d	12 mm
L	46 mm
Gewinde	M16 x 1,5
Bruttogewicht	0,48 kg
Verpackungsmaße	85x85x115 h mm
EAN-Code	8012667313975



Aufhängbar

HSS