

TO PERFORM CONICAL COUNTERSINKS WITHOUT VIBRATIONS.

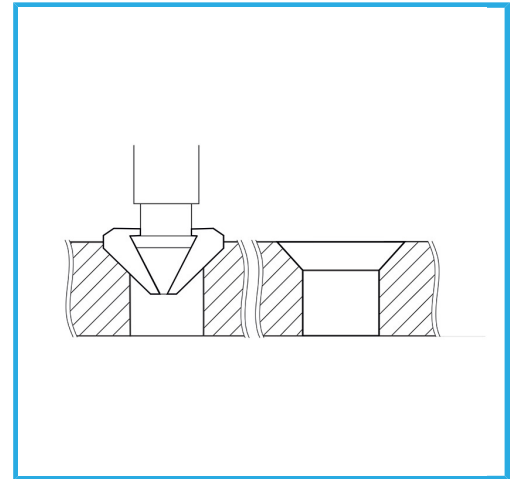

∅	8,3 mm
Total length	31 mm
Shank dimensions	1/4" HEX x 25 mm
Gross weight	0,01 kg
EAN Code	8012667311810



Box



90°

HSS
M2

-