

PARA REALIZAR AVELLANADOS CÓNICOS SIN VIBRACIONES.

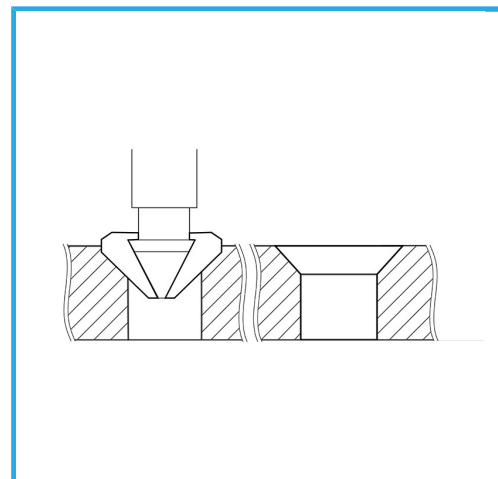

€9,90



∅	8,3 mm
Longitud total	31 mm
Dimensiones pata	1/4" HEX x 25 mm
Peso bruto	0,01 kg
Codigo de barras	8012667311810



Caja



90°

HSS
M2

-