

TO PERFORM CONICAL COUNTERSINKS WITHOUT VIBRATIONS.

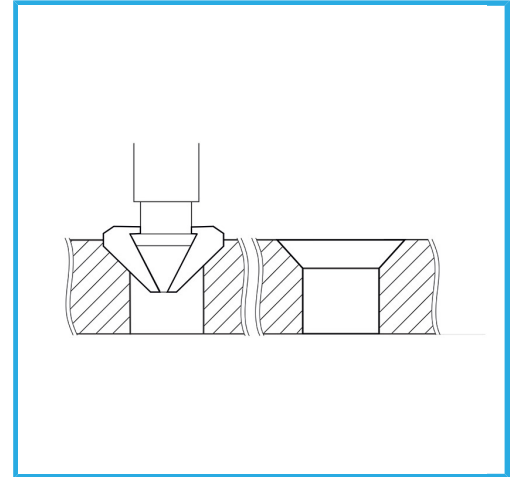

∅	16,5 mm
Total length	40 mm
Shank dimensions	1/4" HEX x 25 mm
Gross weight	0,03 kg
EAN Code	8012667311841



Box



90°

HSS
M2

-