

PARA REALIZAR AVELLANADOS CÓNICOS SIN VIBRACIONES.

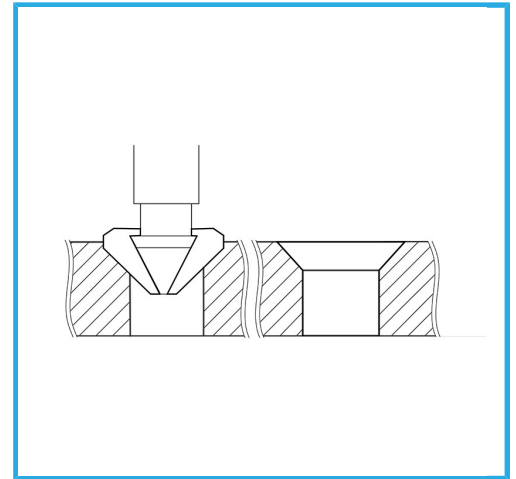

€12,40



| | |
|------------------|------------------|
| ∅ | 16,5 mm |
| Longitud total | 40 mm |
| Dimensiones pata | 1/4" HEX x 25 mm |
| Peso bruto | 0,03 kg |
| Codigo de barras | 8012667311841 |



Caja



90°

HSS
M2

-