

PROFESSIONAL SERIES. IN COMPOSITE MATERIAL, HANDLE AND HEAD IN SHOCKPROOF RUBBER. OPERATING LEVER, CHANGE OF ROTATION AND SPEED..

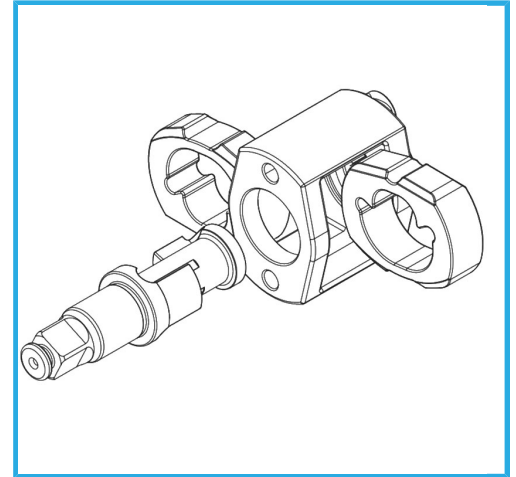

Speed	8500 rpm
Torque	542 Nm 400 lb-ft
Avg air cons.	108 l/min 3.8 SCFM
Working pressure	6 bar 90 psi
Air inlet	1/4"
Net weight	1,2 kg
Gross weight	1,33 kg
EAN Code	8012667346270

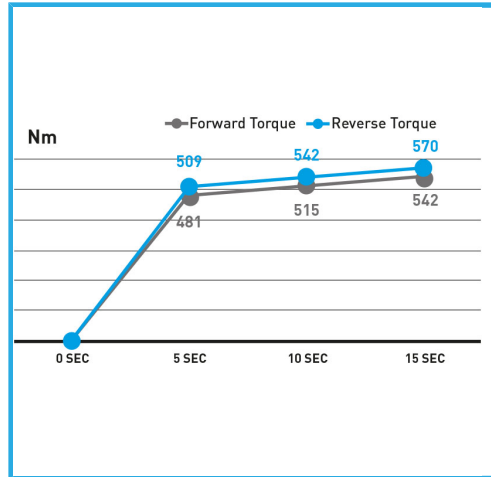

Box



3/8"