

ART. L018S
SOLID CAP SCREW COUNTER BORE SET BEFORE THREAD

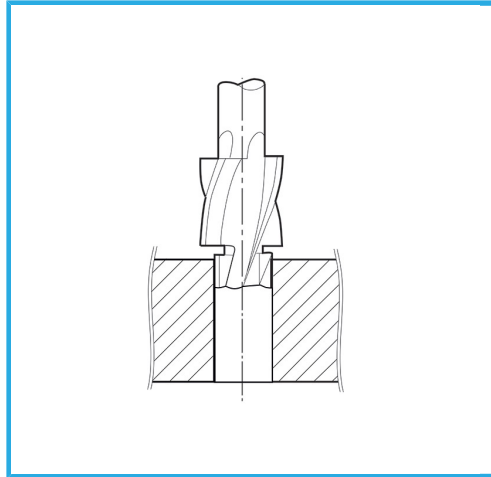







FOR PRE-DRILLED THREADS.



For screws
Gross weight
EAN Code

M3, M4, M5, M6, M8, M10
0,41 kg
8012667346577

	Hangable		External
	6 Pcs		373
	-		-