

MIT POLIERTEM MAGNETBOHRER, GRIFF AUS
ZWEIKOMPONENTENMATERIAL MIT DREHBAREM ENDTEIL FÜR
PERFEKTEN HALT.

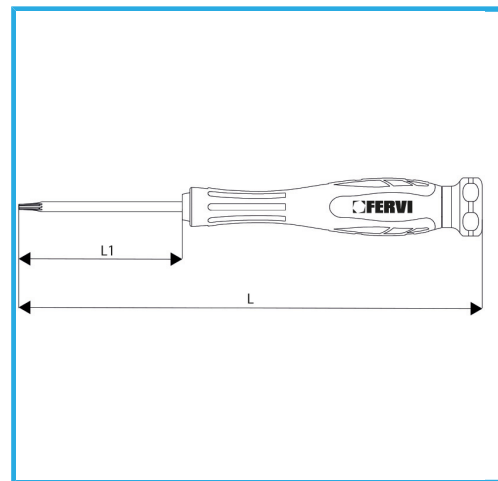

Maß	T5 mm
Stangenlänge	50 mm
Gesamtlänge	140 mm
Verpackungsmaße	19x19x140h
Bruttogewicht	0,02 kg
EAN-Code	8012667349073



Cr-V



Phosph.