

CON PUNTA MAGNETICA BRUNITA, IMPUGNATURA IN MATERIALE BICOMPONENTE CON PARTE TERMINALE LIBERA DI RUOTARE PER UN PERFETTO GRIP.

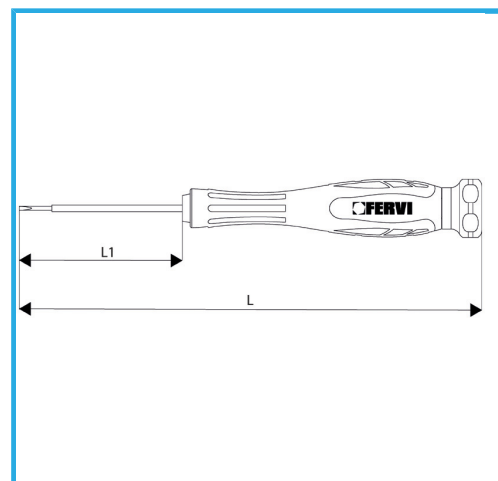

€2,82



Misura	3,0 mm
Lunghezza asta	50 mm
Lunghezza totale	140 mm
Peso lordo	0,02 kg
Dimensioni imballo	19x19x143h
Codice EAN	8012667349011



Fosfatata



-