

€15,50

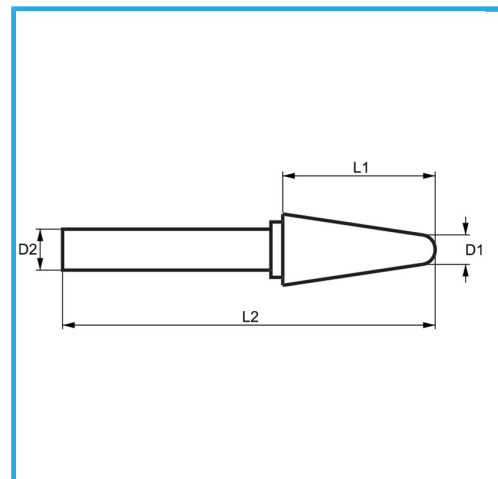

D1	ø8 mm
L1	22 mm
D2	6 mm
L2	65 mm
Dimensioni imballo	17 x 95 x 17 h mm
Peso lordo	0,02 kg
Codice EAN	8012667357757

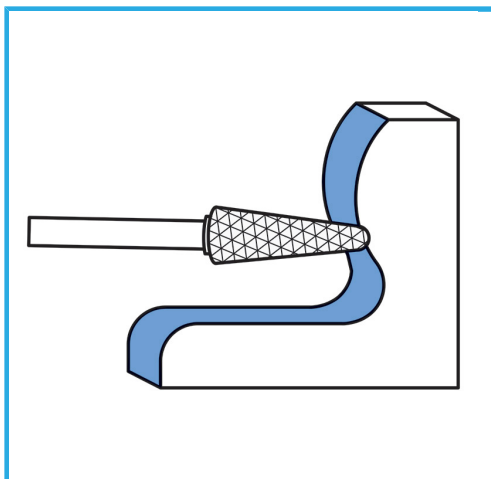

Scatola



HM