

€26,60

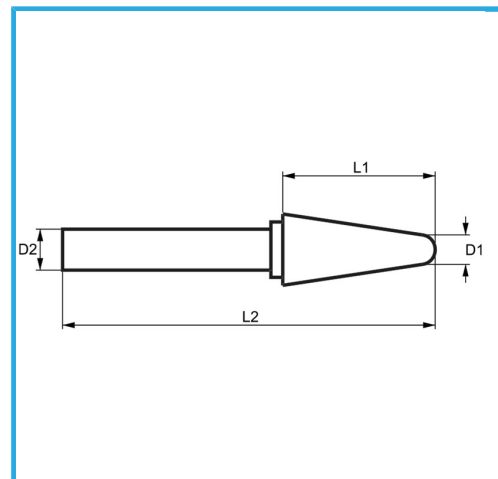

D1	ø12 mm
L1	25 mm
D2	6 mm
L2	70 mm
Dimensioni imballo	17 x 95 x 17 h mm
Peso lordo	0,04 kg
Codice EAN	8012667357771

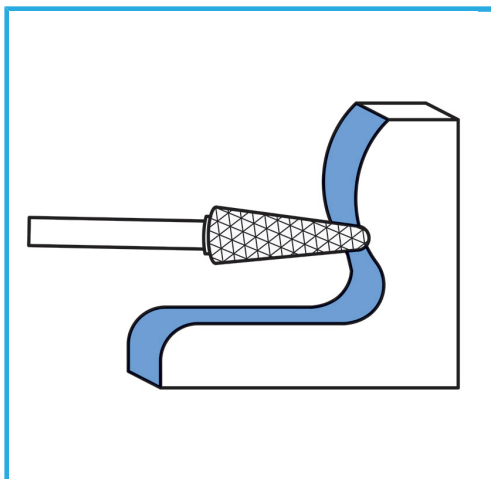

Scatola



HM