

SUITABLE FOR THREAD REGENERATION OR TO OBTAIN VERY RESISTANT TAPPING IN SOFT MATERIALS.

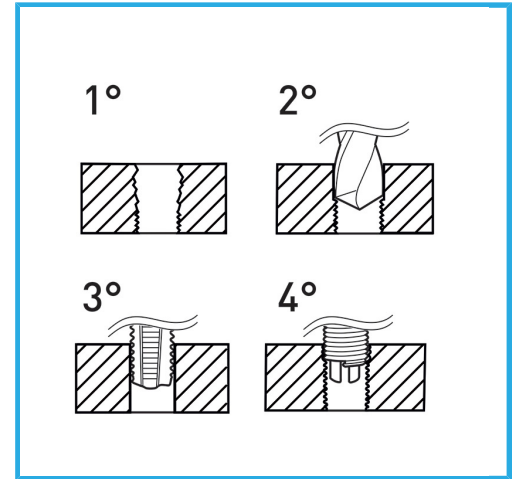

Thread	5/8" x 14
Boring bit	-
STI Taps	E011/BSF5/8M
Inserting tool	E011/U18
Tang break tool	-
Wire-thread inserts	E010/BSF5/8E15
Inserts quantity	10
Gross weight	0,68 kg
EAN Code	8012667369057



Hangable

HSS

INOX