

SUITABLE FOR THREAD REGENERATION OR TO OBTAIN VERY RESISTANT TAPPING IN SOFT MATERIALS.

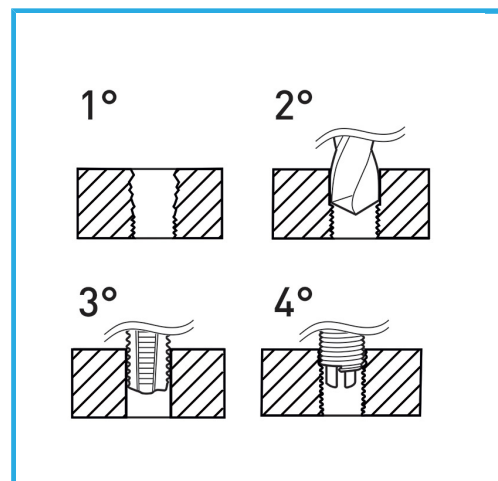

Dimensions	M 14 x 2.0
Boring bit	-
STI Taps	E011/M140X200M
Inserting tool	E011/U17
Tang break tool	-
Inserts quantity	10
Gross weight	0,60 kg
EAN Code	8012667363130



Hangable

HSS

INOX