

SUITABLE FOR THREAD REGENERATION OR TO OBTAIN VERY RESISTANT TAPPING IN SOFT MATERIALS.

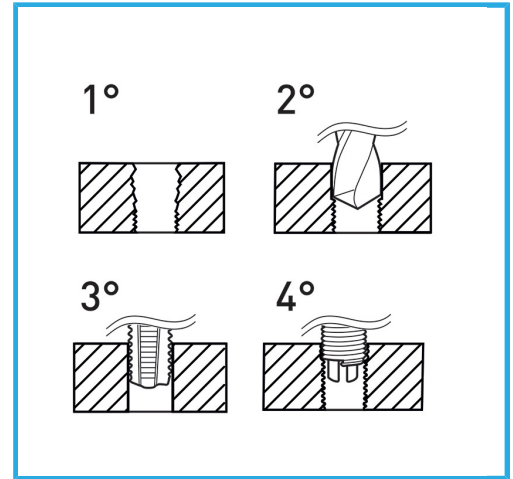

| | |
|----------------------------|----------------|
| Thread | 7/8" x 9 |
| Boring bit | - |
| STI Taps | E011/BSW7/8M |
| Inserting tool | E011/U22 |
| Tang break tool | - |
| Wire-thread inserts | E010/BSW7/8E15 |
| Inserts quantity | 5 |
| Gross weight | 1,00 kg |
| EAN Code | 8012667362812 |



Hangable

HSS



INOX