

SUITABLE FOR THREAD REGENERATION OR TO OBTAIN VERY RESISTANT TAPPING IN SOFT MATERIALS.

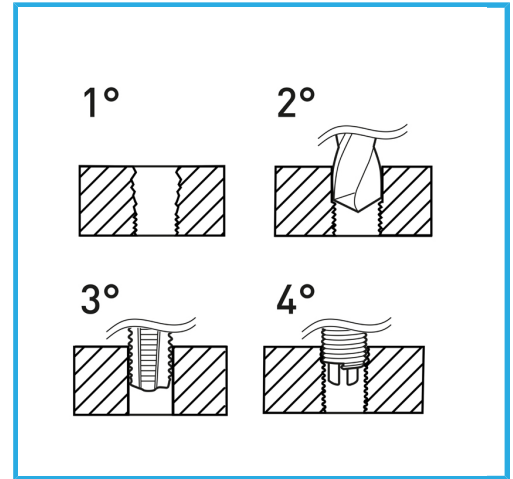

Thread	3/8" x 16
Drills	Ø 9.9 mm
STI Taps	E011/UNC3/8M
Inserting tool	E011/U06
Tang break tool	E011/A06
Wire-thread inserts	E010/UNC3/8E15
Inserts quantity	20
Gross weight	0,52 kg
EAN Code	8012667365561



Hangable

HSS



INOX