

SUITABLE FOR THREAD REGENERATION OR TO OBTAIN VERY RESISTANT TAPPING IN SOFT MATERIALS.

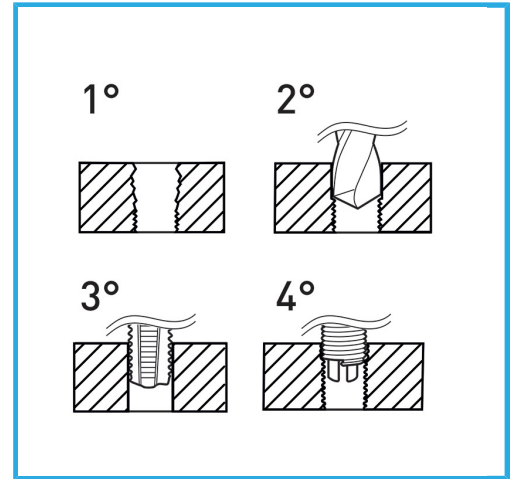

Dimensions	M 7 x 1.0
Boring bit	Ø 7.3 mm
STI Taps	E011/M070X100M
Inserting tool	E011/U10
Tang break tool	E011/A11
Inserts quantity	20
Gross weight	0,42 kg
EAN Code	8012667363802



Hangable

HSS



INOX