

SUITABLE FOR THREAD REGENERATION OR TO OBTAIN VERY RESISTANT TAPPING IN SOFT MATERIALS.

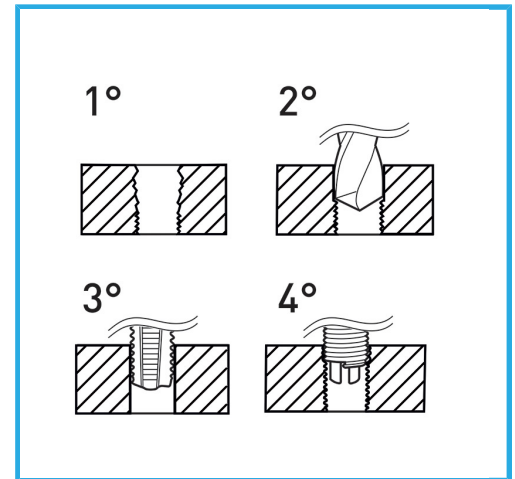

<b>Dimensions</b>	M 4 x 0.7
<b>Boring bit</b>	Ø 4.2 mm
<b>STI Taps</b>	E011/M040X070M
<b>Inserting tool</b>	E011/U06
<b>Tang break tool</b>	E011/A06
<b>Inserts quantity</b>	20
<b>Gross weight</b>	0,35 kg
<b>EAN Code</b>	8012667367589



Hangable

HSS



INOX