

INDICADO PARA LA REGENERACIÓN DE ROSCAS O PARA OBTENER ROSCADOS MUY RESISTENTES EN MATERIALES BLANDOS.

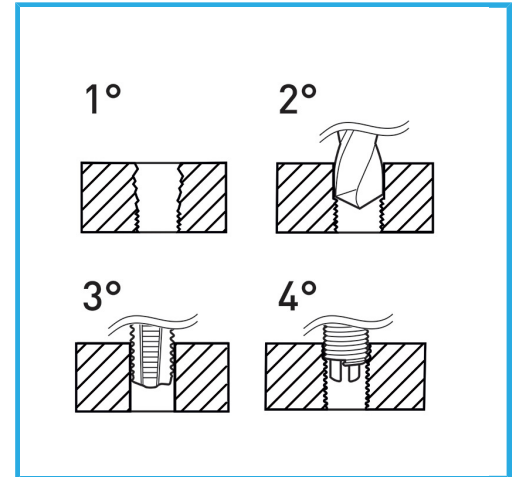

€27,50



Dimensiones	M 4 x 0.7
Broca	Ø 4.2 mm
Machos STI	E011/M040X070M
Utensilio para insertar	E011/U06
Herr. rompe arrastre	E011/A06
Cantidad de insertos	20
Peso bruto	0,35 kg
Codigo de barras	8012667367589



Colgante

HSS



INOX