

SUITABLE FOR THREAD REGENERATION OR TO OBTAIN VERY RESISTANT TAPPING IN SOFT MATERIALS.

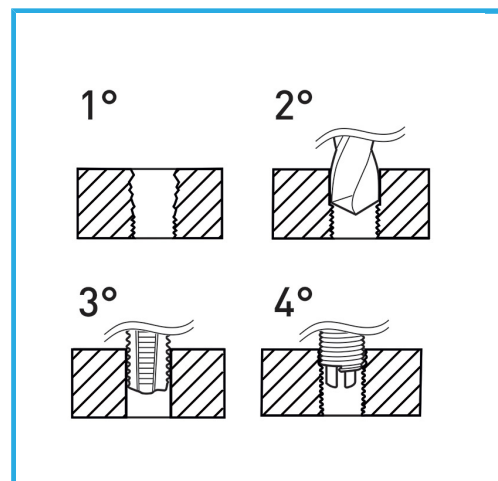

Dimensions	M 12 x 1.0
Boring bit	Ø 12.3 mm
STI Taps	E011/M120X100M
Inserting tool	E011/U15
Tang break tool	E011/A15
Inserts quantity	10
Gross weight	0,65 kg
EAN Code	8012667368876



Hangable

HSS



INOX