

SUITABLE FOR THREAD REGENERATION OR TO OBTAIN VERY RESISTANT TAPPING IN SOFT MATERIALS.

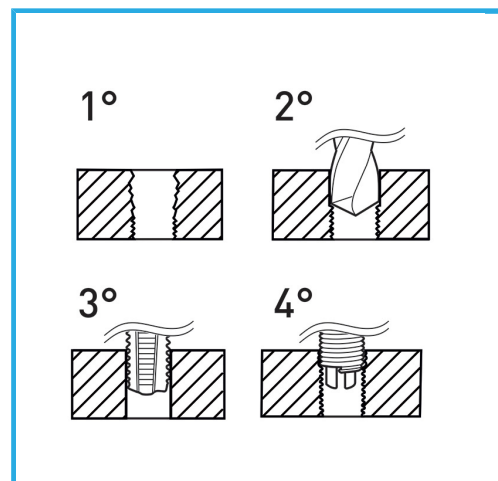

Thread	1/2" x 16
Boring bit	Ø 13.0 mm
STI Taps	E011/BSF1/2M
Inserting tool	E011/U15
Tang break tool	E011/A15
Wire-thread inserts	E010/BSF1/2E15
Inserts quantity	10
Gross weight	0,66 kg
EAN Code	8012667363543



Hangable

HSS



INOX