

SUITABLE FOR THREAD REGENERATION OR TO OBTAIN VERY RESISTANT TAPPING IN SOFT MATERIALS.

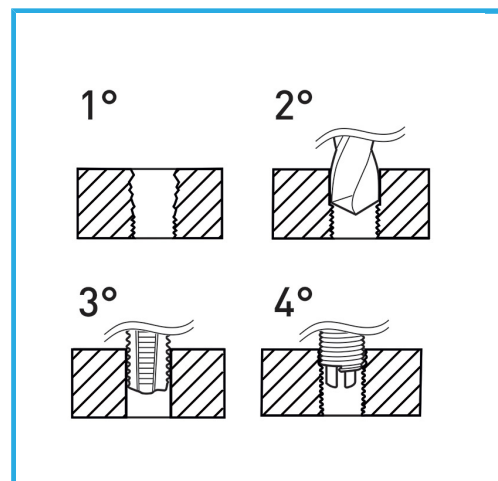

Dimensions	M 22 x 2.0
Boring bit	-
STI Taps	E011/M220X200M
Inserting tool	E011/U22
Tang break tool	-
Inserts quantity	5
Gross weight	0,92 kg
EAN Code	8012667369118



Hangable

HSS

INOX