

SUITABLE FOR THREAD REGENERATION OR TO OBTAIN VERY RESISTANT TAPPING IN SOFT MATERIALS.

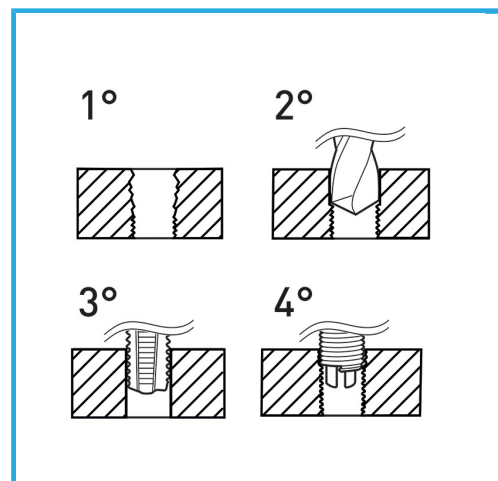

Dimensions	M 16 x 1.5
Boring bit	-
STI Taps	E011/M160X150M
Inserting tool	E011/U18
Tang break tool	-
Inserts quantity	10
Gross weight	0,67 kg
EAN Code	8012667368074



Hangable

HSS



INOX