

SUITABLE FOR THREAD REGENERATION OR TO OBTAIN VERY RESISTANT TAPPING IN SOFT MATERIALS.

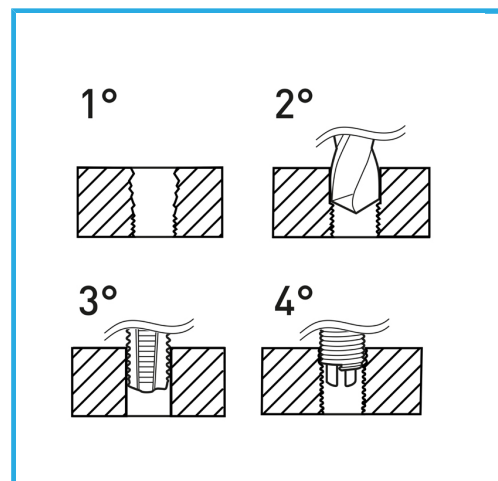

<b>Thread</b>	3/8" x 24
<b>Drills</b>	Ø 9.8 mm
<b>STI Taps</b>	E011/UNF3/8M
<b>Inserting tool</b>	E011/U13
<b>Tang break tool</b>	E011/A13
<b>Wire-thread inserts</b>	E010/UNF3/8E15
<b>Inserts quantity</b>	15
<b>Gross weight</b>	0,52 kg
<b>EAN Code</b>	8012667365462



Hangable

HSS



INOX