

SUITABLE FOR THREAD REGENERATION OR TO OBTAIN VERY RESISTANT TAPPING IN SOFT MATERIALS.

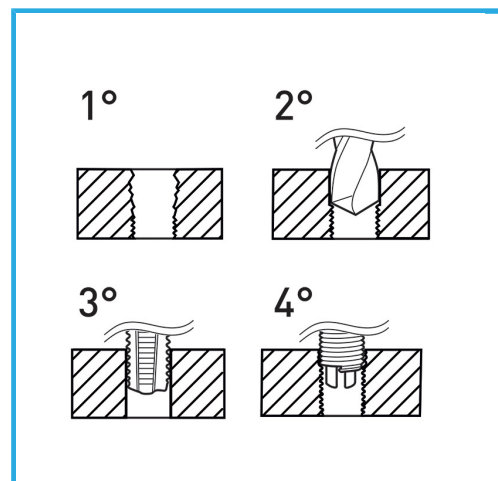

<b>Thread</b>	1/4" x 20
<b>Boring bit</b>	Ø 6.7 mm
<b>STI Taps</b>	E011/BSW1/4M
<b>Inserting tool</b>	E011/U09
<b>Tang break tool</b>	E011/A9
<b>Wire-thread inserts</b>	E010/BSW1/4E15
<b>Inserts quantity</b>	20
<b>Gross weight</b>	0,41 kg
<b>EAN Code</b>	8012667365455



Hangable

HSS



INOX