

SPECIFIC FOR REPAIRS OR REINFORCEMENT OF SPARK PLUG SEATS.

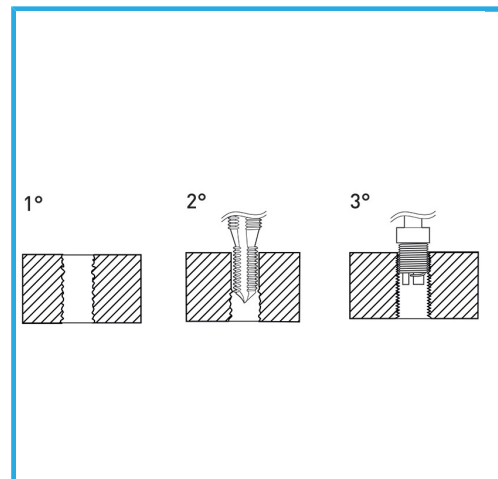

| | |
|---------------------|----------------|
| Size | M 12 x 1.25 |
| Inserting tool | E011/U15 |
| STI Taps | E011/M120X125M |
| Wire-thread inserts | 10 |
| EAN Code | 8012667365110 |
| Gross weight | - |

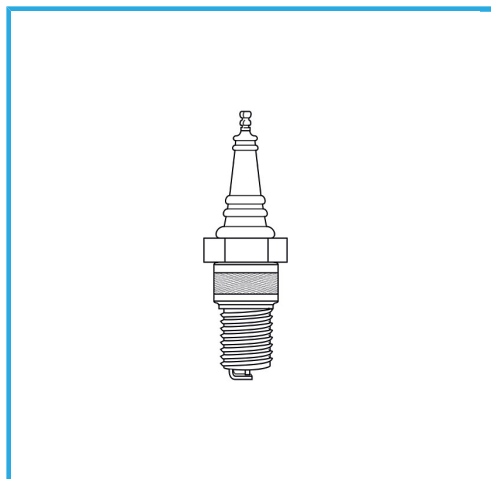

Hangable

HSS



INOX