

SUITABLE FOR THREAD REGENERATION OR TO OBTAIN VERY RESISTANT TAPPING IN SOFT MATERIALS.

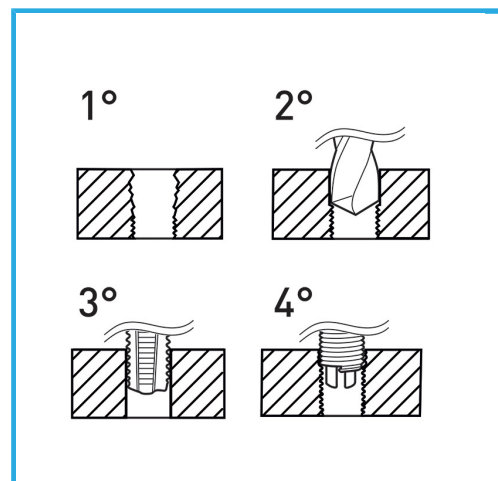

<b>Thread</b>	1/2" x 12
<b>Boring bit</b>	Ø 13.0 mm
<b>STI Taps</b>	E011/BSW1/2M
<b>Inserting tool</b>	E011/U15
<b>Tang break tool</b>	E011/A15
<b>Wire-thread inserts</b>	E010/BSW1/2E15
<b>Inserts quantity</b>	10
<b>Gross weight</b>	0,70 kg
<b>EAN Code</b>	8012667368005



Hangable

HSS

INOX