

ESPECÍFICO PARA REPARACIONES O REFUERZO DE ASIENTOS DE BUJÍAS.

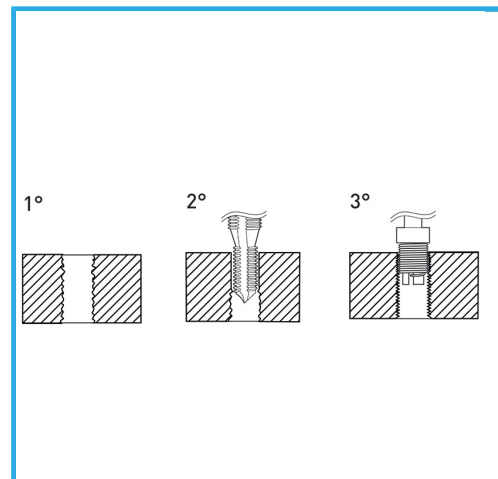

€46,30

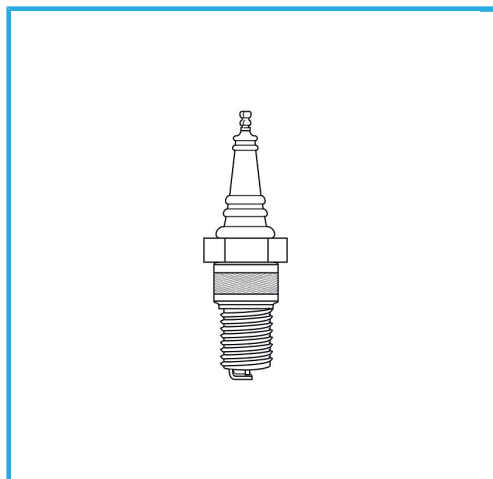

Medida	M 10 x 1.25
Utensilio para insertar	E011/U13
Machos STI	E011/M100X125M
Insertos roscados	10
Codigo de barras	8012667366186
Peso bruto	-



Colgante

HSS



INOX