

SPECIFIC FOR REPAIRS OR REINFORCEMENT OF SPARK PLUG SEATS.

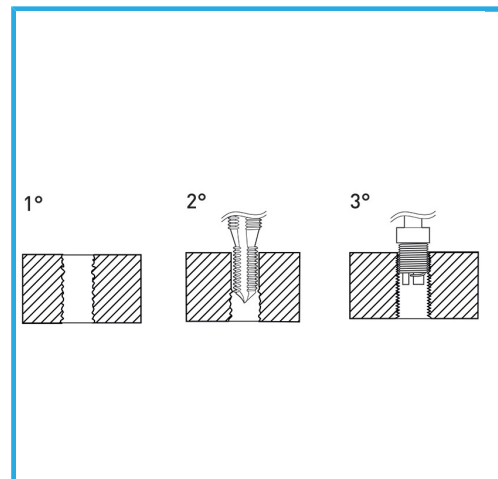

Size	M 10 x 1.0
Inserting tool	E011/U13
STI Taps	E011/M100X100M
Wire-thread inserts	10
EAN Code	8012667363666
Gross weight	-

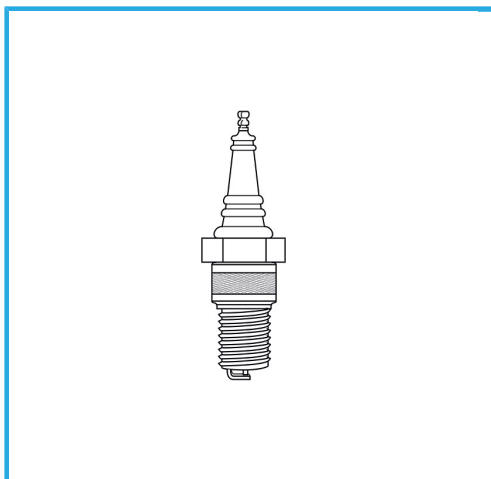

Hangable

HSS



INOX