

SUITABLE FOR THREAD REGENERATION OR TO OBTAIN VERY RESISTANT TAPPING IN SOFT MATERIALS.

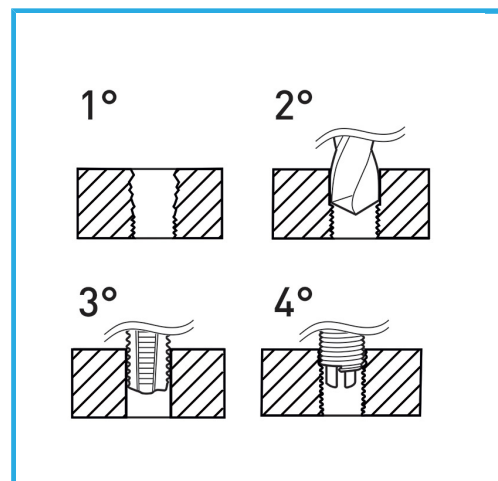

Dimensions	M 5 x 0.8
Boring bit	Ø 5.2 mm
STI Taps	E011/M050X080M
Inserting tool	E011/U08
Tang break tool	E011/A08
Inserts quantity	20
Gross weight	0,38 kg
EAN Code	8012667363567



Hangable

HSS



INOX