

SUITABLE FOR THREAD REGENERATION OR TO OBTAIN VERY RESISTANT TAPPING IN SOFT MATERIALS.

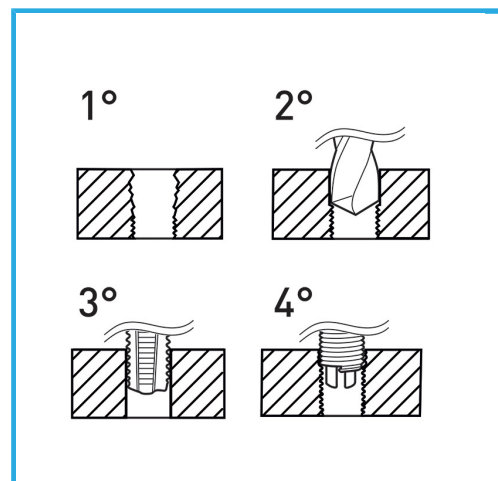

<b>Thread</b>	1/8" x 40
<b>Boring bit</b>	Ø 3.4 mm
<b>STI Taps</b>	E011/BSW1/8M
<b>Inserting tool</b>	E011/U04
<b>Tang break tool</b>	E011/A4
<b>Wire-thread inserts</b>	E010/BSW1/8E15
<b>Inserts quantity</b>	20
<b>Gross weight</b>	0,35 kg
<b>EAN Code</b>	8012667369033



Hangable

HSS

INOX