

SUITABLE FOR THREAD REGENERATION OR TO OBTAIN VERY RESISTANT TAPPING IN SOFT MATERIALS.

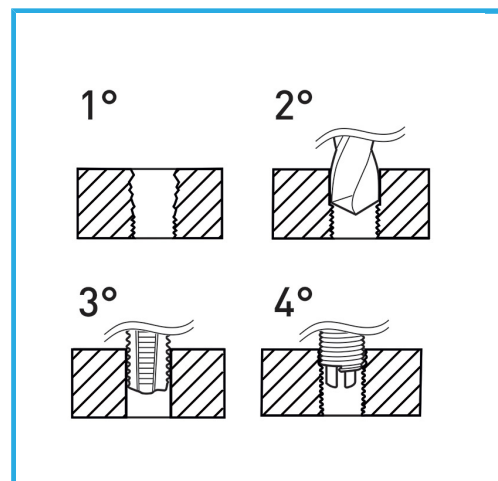

Dimensions	M 20 x 2.5
Boring bit	-
STI Taps	E011/M200X250M
Inserting tool	E011/U21
Tang break tool	-
Inserts quantity	5
Gross weight	0,88 kg
EAN Code	8012667366278



Hangable

HSS



INOX