

SPECIFIC FOR REPAIRS OR REINFORCEMENT OF SPARK PLUG SEATS.

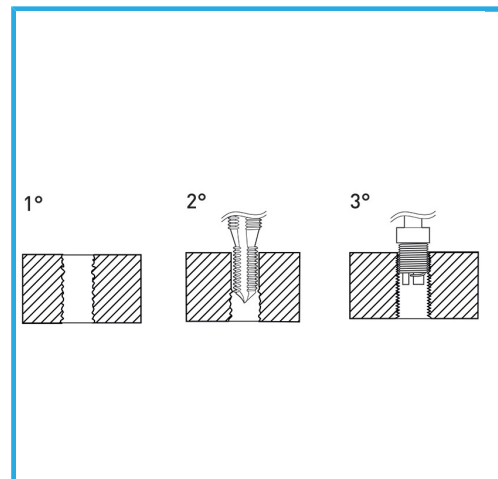

Size	M 6 x 1.0
Inserting tool	E011/U09
STI Taps	E011/M060X100M
Wire-thread inserts	10
EAN Code	8012667366483
Gross weight	-

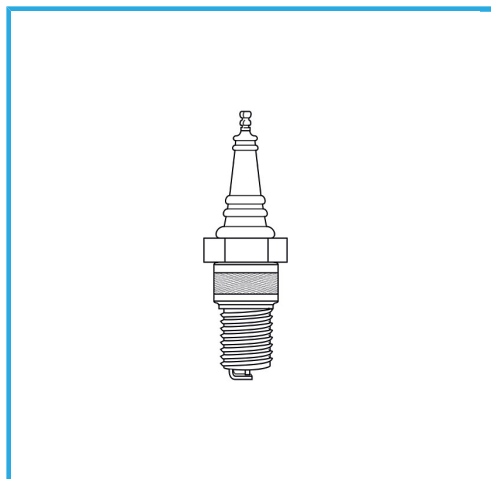

Hangable

HSS



INOX