

SUITABLE FOR THREAD REGENERATION OR TO OBTAIN VERY RESISTANT TAPPING IN SOFT MATERIALS.

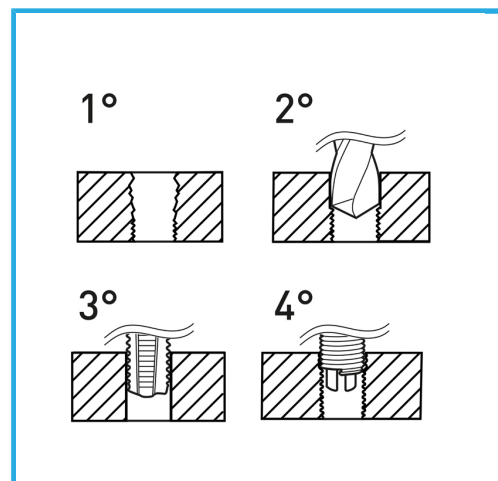

Thread	5/8" x 1
Drills	-
STI Taps	E011/UNC5/8M
Inserting tool	E011/U18
Tang break tool	-
Wire-thread inserts	E010/UNC5/8E15
Inserts quantity	10
Gross weight	0,72 kg
EAN Code	8012667367671



Hangable

HSS



INOX