

SUITABLE FOR THREAD REGENERATION OR TO OBTAIN VERY RESISTANT TAPPING IN SOFT MATERIALS.

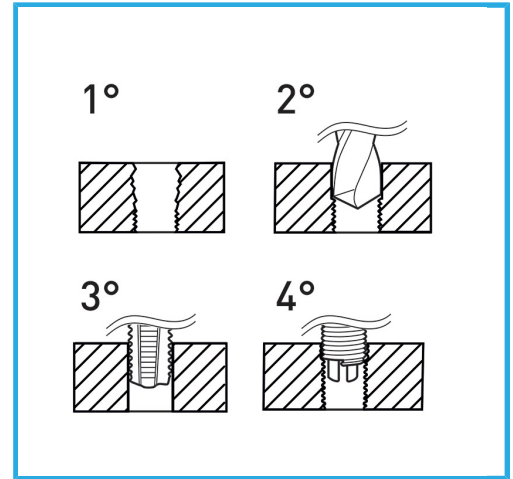

Dimensions	M 10 x 1.0
Boring bit	Ø 10.3 mm
STI Taps	E011/M100X100M
Inserting tool	E011/U13
Tang break tool	E011/A13
Inserts quantity	15
Gross weight	0,53 kg
EAN Code	8012667366568



Hangable

HSS

INOX