

SUITABLE FOR THREAD REGENERATION OR TO OBTAIN VERY RESISTANT TAPPING IN SOFT MATERIALS.

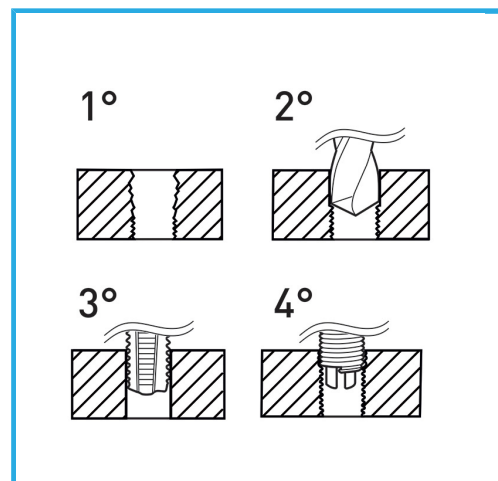

Thread	9/16" x 16
Boring bit	-
STI Taps	E011/BSF9/16M
Inserting tool	E011/U16
Tang break tool	-
Wire-thread inserts	E010/BSF9/16E15
Inserts quantity	10
Gross weight	0,60 kg
EAN Code	8012667365646



Hangable

HSS

INOX