

SUITABLE FOR THREAD REGENERATION OR TO OBTAIN VERY RESISTANT TAPPING IN SOFT MATERIALS.

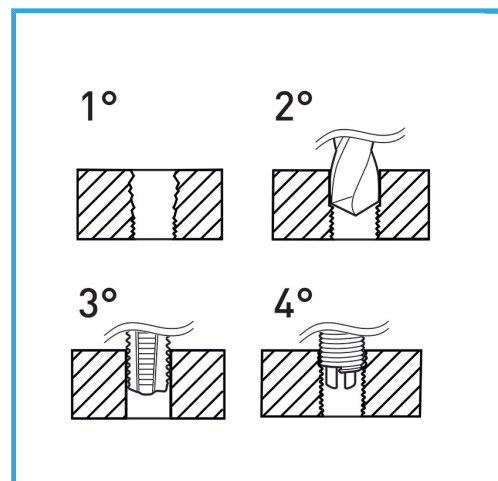

<b>Thread</b>	3/16" x 32
<b>Boring bit</b>	Ø 5.0 mm
<b>STI Taps</b>	E011/BSF3/16M
<b>Inserting tool</b>	E011/U07
<b>Tang break tool</b>	E011/A06
<b>Wire-thread inserts</b>	E010/BSF3/16E15
<b>Inserts quantity</b>	20
<b>Gross weight</b>	0,37 kg
<b>EAN Code</b>	8012667367190



Hangable

HSS



INOX