

INDICADO PARA LA REGENERACIÓN DE ROSCAS O PARA OBTENER ROSCADOS MUY RESISTENTES EN MATERIALES BLANDOS.

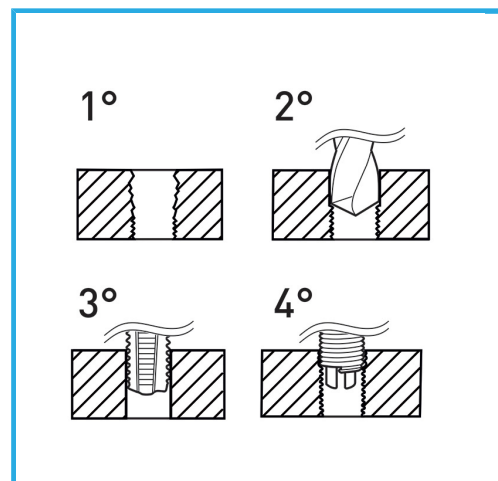

€39,40



Rosca	5/16" x 22
Broca	Ø 8.3 mm
Machos STI	E011/BSF5/16M
Utensilio para insertar	E011/U11
Herr. rompe arrastre	E011/A11
Insertos roscados	E010/BSF5/16E15
Cantidad de insertos	20
Peso bruto	0,48 kg
Codigo de barras	8012667366612



Colgante

HSS



INOX