

SUITABLE FOR THREAD REGENERATION OR TO OBTAIN VERY RESISTANT TAPPING IN SOFT MATERIALS.

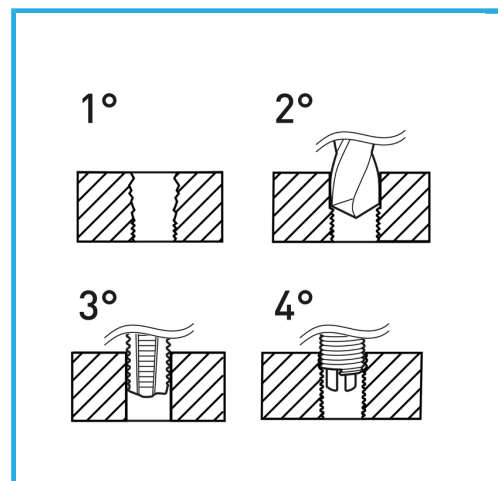

Thread	5/16" x 18
Drills	Ø 8.3 mm
STI Taps	E011/UNC5/16M
Inserting tool	E011/U10
Tang break tool	E011/A11
Wire-thread inserts	E010/UNC5/16E15
Inserts quantity	20
Gross weight	0,46 kg
EAN Code	8012667366414



Hangable

HSS



INOX