

INDICADO PARA LA REGENERACIÓN DE ROSCAS O PARA OBTENER ROSCADOS MUY RESISTENTES EN MATERIALES BLANDOS.

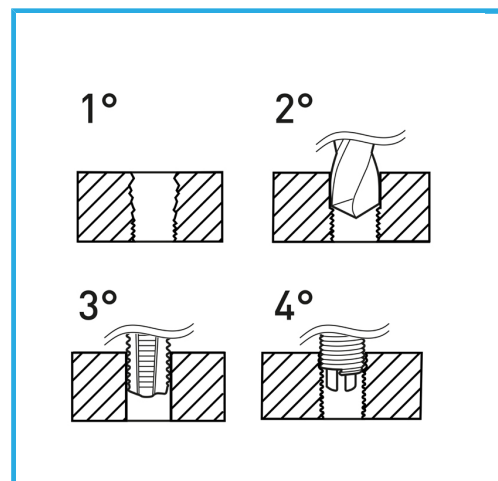

€38,50



Rosca	5/16" x 18
Brocas	Ø 8.3 mm
Machos STI	E011/UNC5/16M
Utensilio para insertar	E011/U10
Herr. rompe arrastre	E011/A11
Insertos roscados	E010/UNC5/16E15
Cantidad de insertos	20
Peso bruto	0,46 kg
Codigo de barras	8012667366414



Colgante

HSS



INOX