

SUITABLE FOR THREAD REGENERATION OR TO OBTAIN VERY RESISTANT TAPPING IN SOFT MATERIALS.

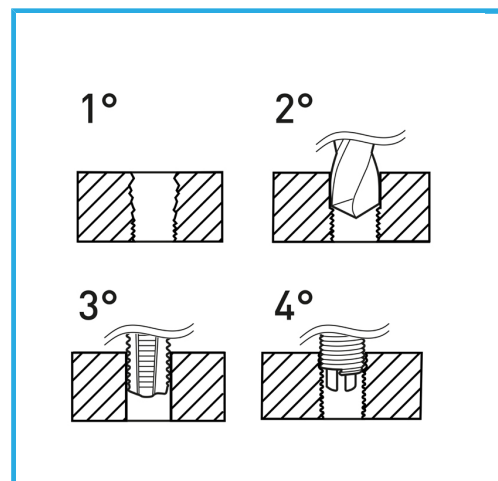

Thread	7/8" x 9
Drills	-
STI Taps	E011/UNC7/8M
Inserting tool	E011/U22
Tang break tool	-
Wire-thread inserts	E010/UNC7/8E15
Inserts quantity	5
Gross weight	1,00 kg
EAN Code	8012667367084



Hangable

HSS



INOX