

INDICADO PARA LA REGENERACIÓN DE ROSCAS O PARA OBTENER ROSCADOS MUY RESISTENTES EN MATERIALES BLANDOS.

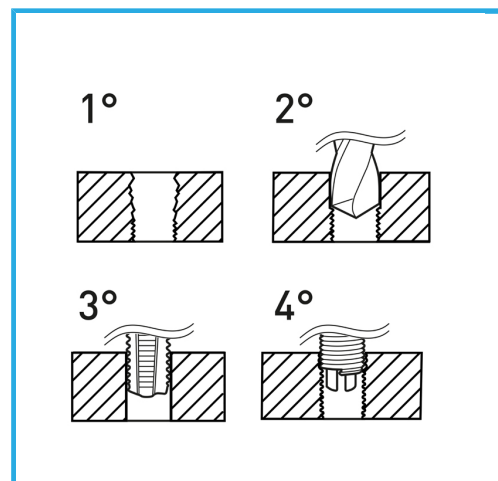

€50,00



Rosca	1/2" x 13
Brocas	Ø 13.0 mm
Machos STI	E011/UNC1/2M
Utensilio para insertar	E011/U15
Herr. rompe arrastre	E011/A15
Insertos roscados	E010/UNC1/2E15
Cantidad de insertos	10
Peso bruto	0,68 kg
Codigo de barras	8012667362966



Colgante

HSS



INOX