

SUITABLE FOR THREAD REGENERATION OR TO OBTAIN VERY RESISTANT TAPPING IN SOFT MATERIALS.

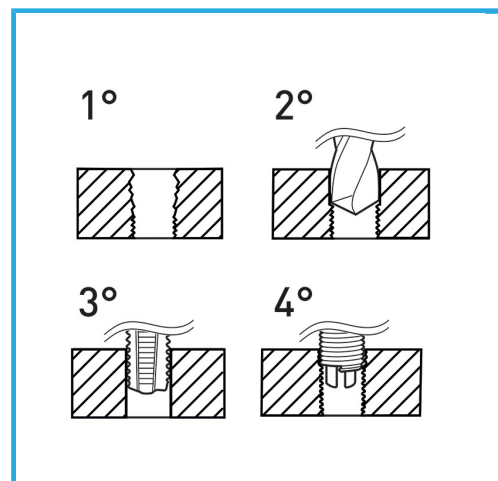

<b>Dimensions</b>	M 8 x 1.25
<b>Boring bit</b>	Ø 8.3 mm
<b>STI Taps</b>	E011/M080X125M
<b>Inserting tool</b>	E011/U11
<b>Tang break tool</b>	E011/A11
<b>Inserts quantity</b>	20
<b>Gross weight</b>	0,47 kg
<b>EAN Code</b>	8012667367442



Hangable

HSS

INOX