

SUITABLE FOR THREAD REGENERATION OR TO OBTAIN VERY RESISTANT TAPPING IN SOFT MATERIALS.

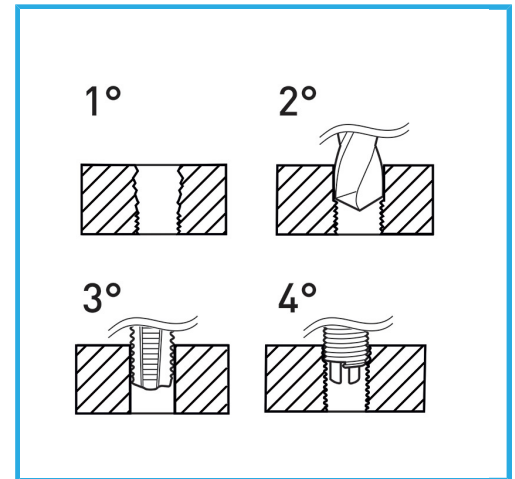

<b>Dimensions</b>	M 9 x 1.25
<b>Boring bit</b>	Ø 9.3 mm
<b>STI Taps</b>	E011/M090X125M
<b>Inserting tool</b>	E011/U12
<b>Tang break tool</b>	E011/A12
<b>Inserts quantity</b>	15
<b>Gross weight</b>	0,49 kg
<b>EAN Code</b>	8012667368692



Hangable

HSS

INOX