

SUITABLE FOR THREAD REGENERATION OR TO OBTAIN VERY RESISTANT TAPPING IN SOFT MATERIALS.

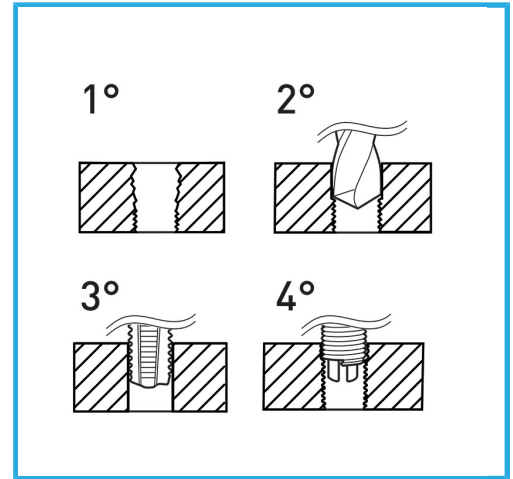

Dimensions	M 16 x 2.0
Boring bit	-
STI Taps	E011/M160X200M
Inserting tool	E011/U18
Tang break tool	-
Inserts quantity	10
Gross weight	0,69 kg
EAN Code	8012667364335



Hangable

HSS



INOX