

SUITABLE FOR THREAD REGENERATION OR TO OBTAIN VERY RESISTANT TAPPING IN SOFT MATERIALS.

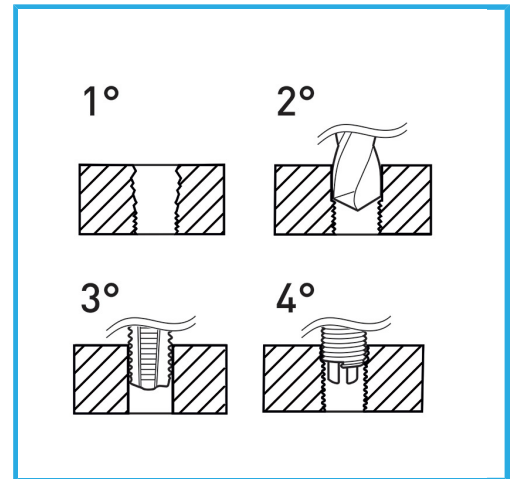

Dimensions	M 11 x 1.5
Boring bit	Ø 11.4 mm
STI Taps	E011/M110X150M
Inserting tool	E011/U14
Tang break tool	E011/A14
Inserts quantity	10
Gross weight	0,55 kg
EAN Code	8012667362713



Hangable

HSS



INOX