

SUITABLE FOR THREAD REGENERATION OR TO OBTAIN VERY RESISTANT TAPPING IN SOFT MATERIALS.

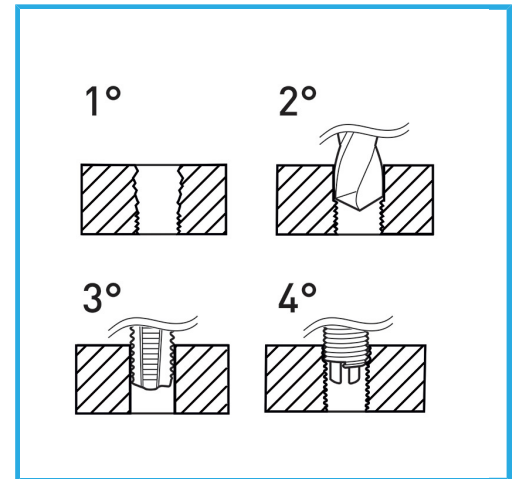

Dimensions	M 2 x 0.4
Boring bit	Ø 2.1 mm
STI Taps	E011/M020X040M
Inserting tool	E011/U02
Tang break tool	E011/A02
Inserts quantity	20
Gross weight	0,32 kg
EAN Code	8012667367848



Hangable

HSS



INOX