

FOR CENTRING WITHIN EXISTING BORES, THE SPRING-LOADED,
CONICAL FRONT PROVIDES ACCURATE CENTRING.

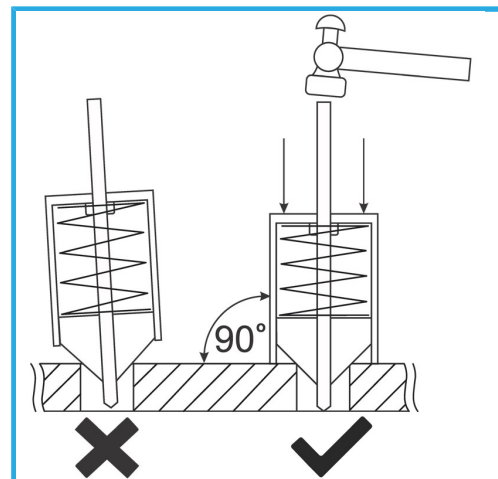

Length	82 mm
Hole diameter	Ø5 - Ø15 mm
Gross weight	0,12 kg
EAN Code	8012667408268



Box



Steel