

WITH HARDENED AND GROUND TOOTHING. BY ACTING ON AN ECCENTRIC PIN, THE TOOL HOLDER IS LOCKED ON THE TOOTHING OF THE BODY. IT...

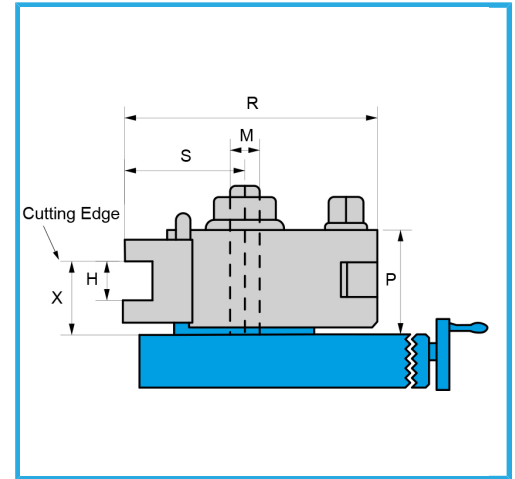

R max	100 mm
S max	54 mm
P	48 mm
H	16 mm
X min	30 mm
Gross weight	4,66 kg
EAN Code	8012667189433



Box